

LAG-91065MK

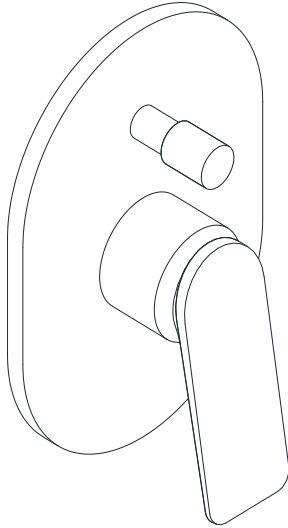

TECHNICAL DRAWING

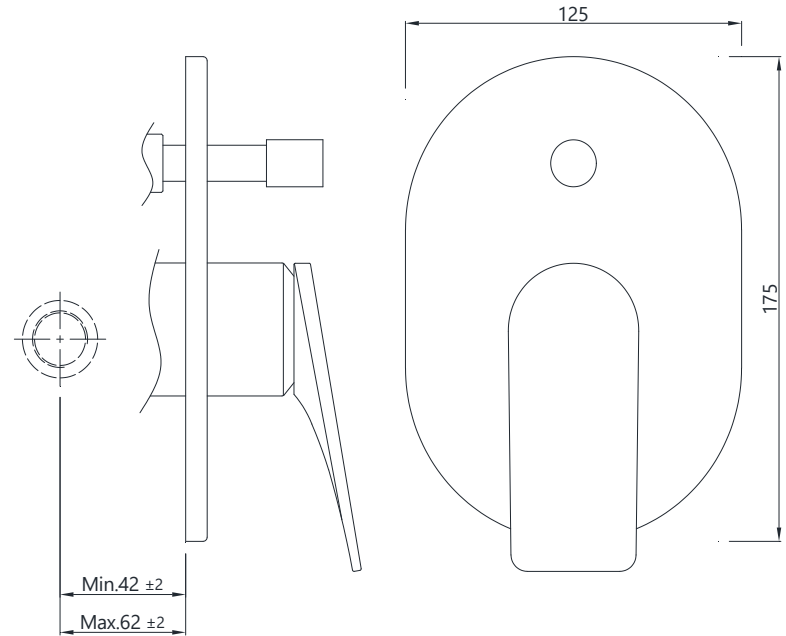

TEMP.& WATER PRESSURE REQUIREMENTS

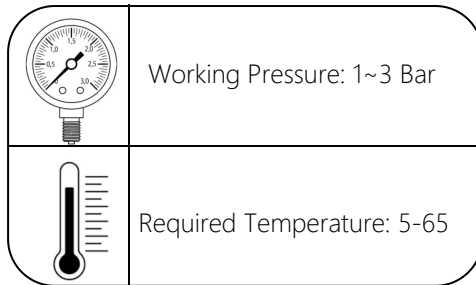

Note: Above values are the recommend values for Getting Conventional Outputs.

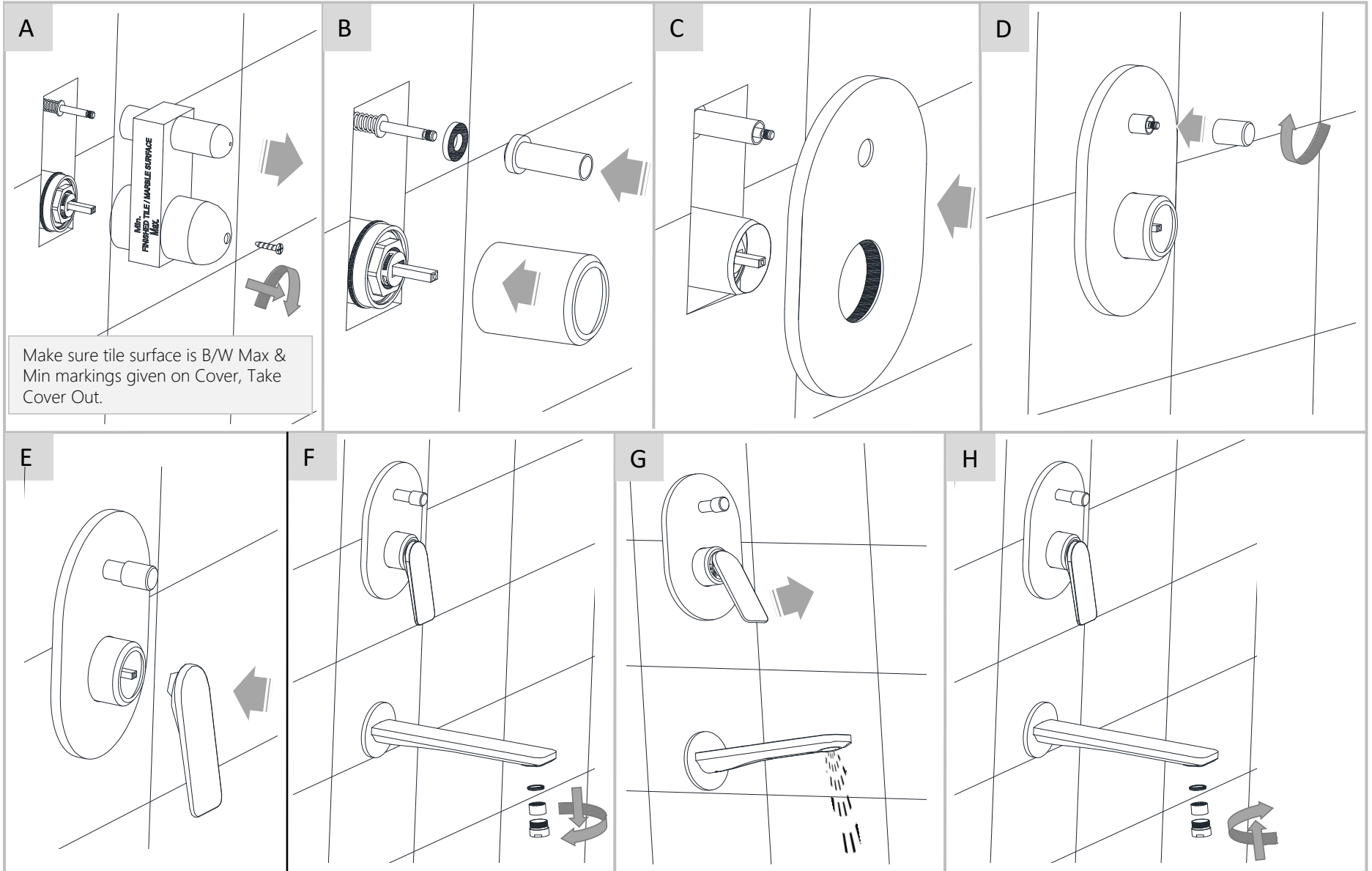

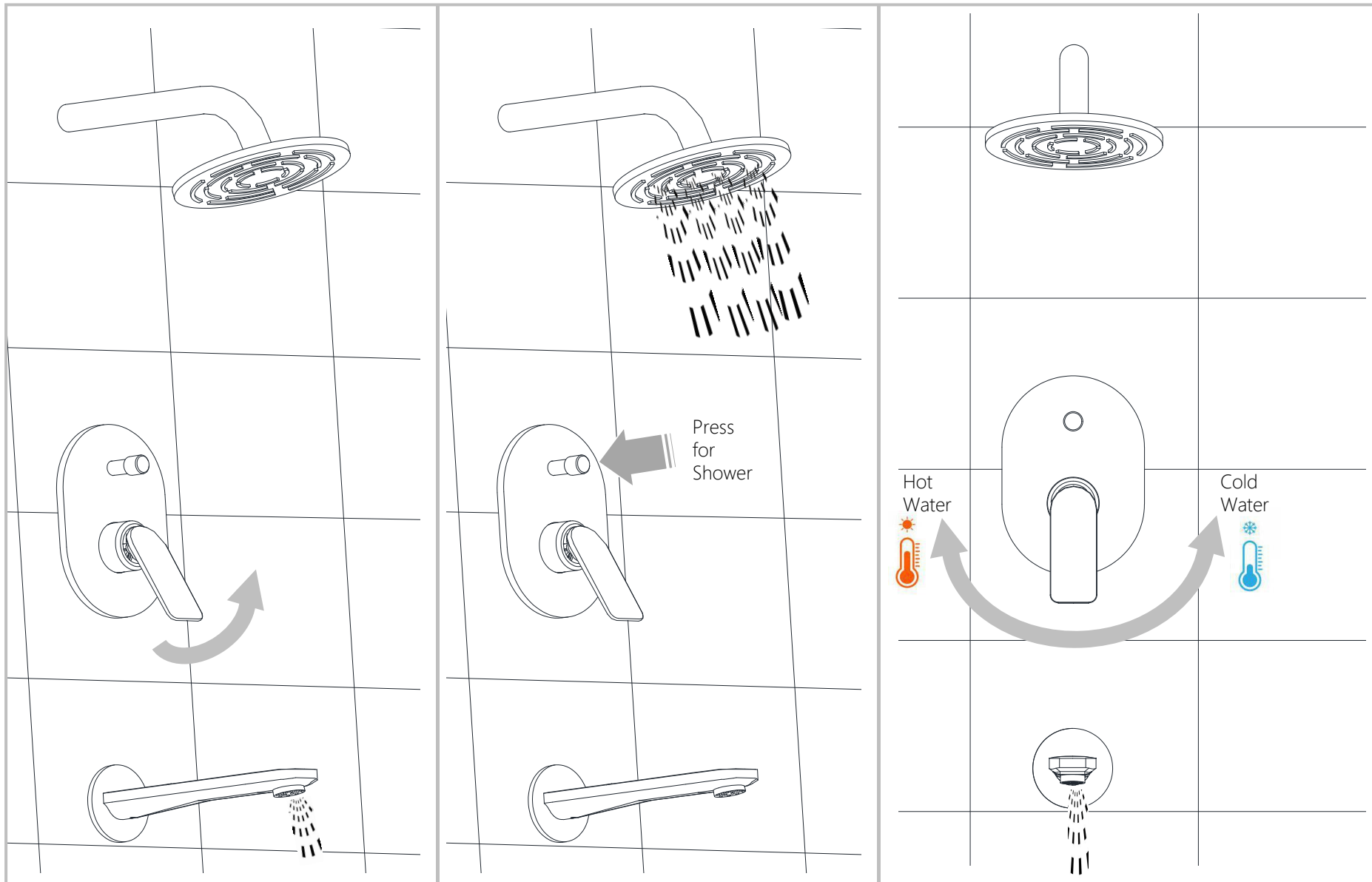



Apply soft cotton cloth

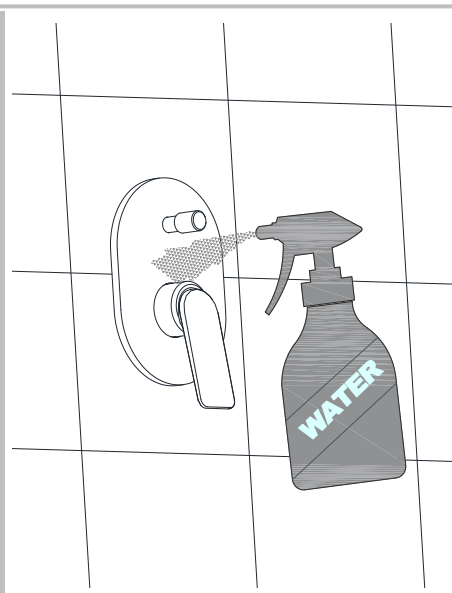
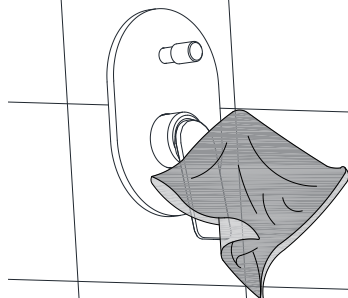

Apply soft cotton cloth

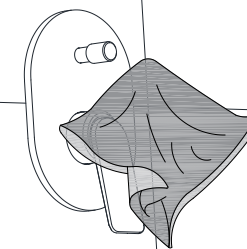

✗ DON'T

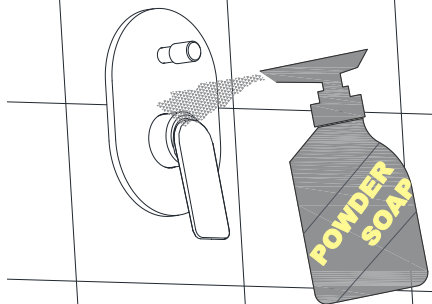

✗ DON'T

Don't apply Scrub

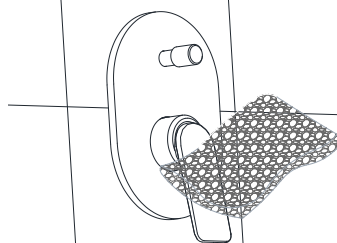

Steps & Cleaning agents requirements for Aerator Cleaning.

